

Gateway Selection Architecture Using Multiple Metrics for Vehicular Networking

Jirawat Thaenthong and Steven Gordon
Sirindhorn International Institute of Technology, Thammasat University,
131 Moo 5, Tiwanont Road, Bangkokdi Muang Pathumthani 12000, Thailand

Abstract: Multi-hop wireless networks formed between vehicles on a highway can provide Internet access to devices onboard vehicles if subsets of vehicles also share 3G/4G wireless connectivity to roadside base stations. In such a scenario mobile routers onboard vehicles should select the optimal gateway (base station) for Internet connectivity. This paper proposed an architecture that allows mobile routers to discover nearby gateways and select the optimal gateways based on various performance metrics. The architecture extends the Neighbour Discovery Protocol so that mobile routers can efficiently learn the identities and capabilities of gateways across multiple hops. A new gateway selection algorithm is presented; the algorithm can use multiple metrics, including gateway throughput, network load, path stability and financial cost, to determine the optimal gateway. Simulation results show that increase in application throughput of 10-20% can be achieved at the expense of small increase in signaling overhead.

Key words: Vehicular networks, ad hoc networks, mobile IP, MANEMO, path reliability, gateway selection

INTRODUCTION

Vehicle communication networks are formed by connecting devices inside public and private vehicles with each other (vehicle-to-vehicle communications) and with fixed communication infrastructure (vehicle-to-infrastructure communications). Providing Internet access to devices (and users) in vehicles enables various applications in safety and emergency warning, traffic management and entertainment. With diverse communication capabilities of devices/vehicles, multi-hop wireless communications will be needed for some vehicles to connect with the road-side infrastructure. That is, a mobile ad hoc network (MANET) is formed between vehicles using IEEE 802.11p wireless links, while selected vehicles also offer 3G/4G links to nearby mobile network base stations (as illustrated in Fig. 1). The vehicles contain fixed and mobile nodes, with a mobile router managing mobility of all nodes in the vehicle on their behalf, thereby offering Network Mobility (NEMO). A problem therefore is which base station, or gateway, should a vehicle use to access the Internet.

In infrastructure-based wireless networks, a mobile node has a single wireless link to a base station or gateway. Therefore, link-level measures can be used to detect available gateways, measure link quality and obtain status information from the gateways to support gateway selection. However when a mobile node is part of a

multiple-hop vehicular network it may not have a direct link to gateways. Therefore, new network-level protocols are needed for a mobile node to discover gateways. Also the best gateway will not depend on just a single link, but the other nodes in the network. Hence appropriate metrics for selecting the gateway are needed (Dhar *et al.*, 2011) and values of these metrics must be obtained such that the network overhead is minimized. Another challenge is minimizing the overhead when performing a handover between gateways using protocols such as Mobile IP and NEMO (Alrashdan *et al.*, 2011, Dinakaran and Balasubramanie, 2012). This paper addresses these problems by presenting a gateway selection architecture that:

- Extends Mobile IPv6/NEMO Route Advertisements to allow mobile nodes to learn about gateways and their capabilities
- Specifies key metrics for selecting an optimal gateway
- Presents an algorithm for selecting the gateway with the aim of improving application performance will minimizing communication overhead

The solution is tailored for highways, where gateways from multiple service providers are nearby the roads and vehicles across multiple lanes form a network

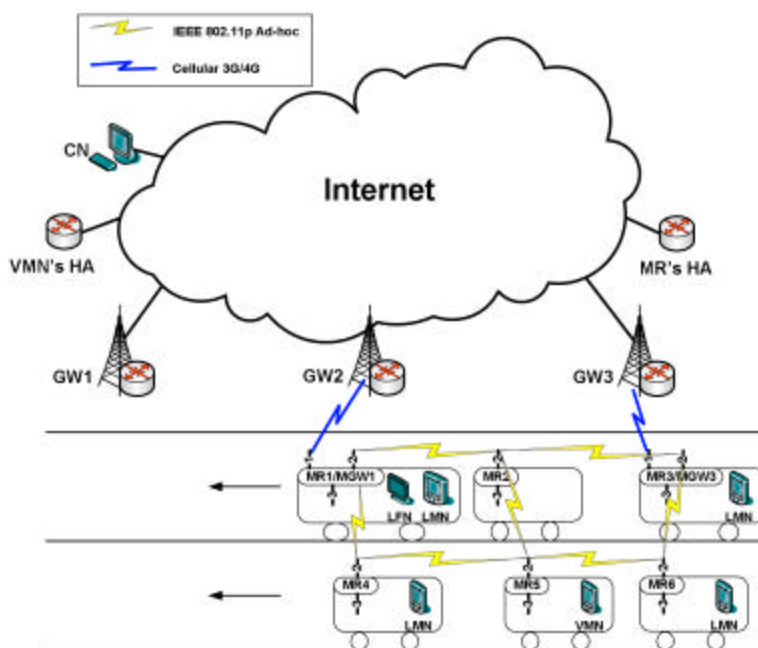

Fig. 1: Topology of example vehicular network with both vehicle-to-vehicle and vehicle-to-infrastructure comments, CN: Correspondent Node, HA: Home Agent, GW: Gateway, MR: Mobile Router, MGW: Mobile Gateway, LFN: Local Fixed Node, LMN: Local Mobile Node, VMN: Visiting Mobile Node

amongst themselves, with a subset of vehicles also connecting to gateways.

Connecting a multi-hop wireless network (including MANET) to the Internet presents several challenges (Ding, 2008), one of those being how mobile nodes select the Internet gateway.

Several researchers have proposed gateway selection algorithms for specific MANET routing protocols. Bin and Bin (2009) modify AODV to use hop count and number of mobile nodes registered at gateways as selection metrics. The algorithm can balance load across multiple gateways. Sun *et al.* (2009) modify OLSR and use the same metrics as Bin and Bin (2009), as well as energy, queue delay and mobility history. These provide useful ideas but are limited to a specific routing protocol and the given metrics. Other metrics considered by researchers include route availability and latency by Bouk and Sasase (2009), path quality by Ma and Liu (2009) and gateway load by Sheng *et al.* (2008). However these algorithms are only tested in small networks of two or less hops. Other hybrid gateway selection algorithms using multiple metrics are proposed by Hoffmann and Medina (2009), Le-Trung *et al.* (2008) and Park *et al.* (2007). However the solutions consider only simple traffic patterns and limited

mobility. Setiawan *et al.* (2009) showed how to normalize metrics within a range of $[0,1]$ and combining them with a weighting function.

Focusing on vehicular networks where the gateway to select is fixed, Benslimane *et al.* (2011a) makes use of the Route Expiration Time (RET) Su *et al.* (2000) to select a gateway that has a reliable path to the mobile node. Benslimane *et al.* (2011b) use a cluster-based routing protocol and multiple metrics, including RET, signal strength and mobility patterns to select gateways. These are promising solutions, but can be improved by considering other metrics, especially application throughput. Another approach by Sheng *et al.* (2008) introduces a mobility management server to assist in gateway selection. Although producing good results, this is limited to networks which are controlled only by a single organization (i.e., does not support roaming between operators).

The aim of this research was to develop generic gateway selection architecture for vehicular networking that is independent of the underlying routing protocol and can support a variety of metrics. Focusing on a highway scenario, a solution is designed that is compatible with standard IP-based protocols, thereby allowing for deployments in a wide range of scenarios.

PROPOSED GATEWAY SELECTION ARCHITECTURE

After setting out the assumed scenario in this research, this section presents a generic protocol for MNs to collect metrics, list a set of metrics that should commonly be supported and the algorithm for selecting gateways.

Scenario and assumptions: The scenario under consideration is a multi-lane straight highway with V vehicles travelling in one direction with speed s_1 . There are roadside gateways evenly spaced, separated by d kilometers. Each vehicle has its own IP subnet. There is one Mobile Router (MR) in the vehicle which, using NEMO (Devarapalli *et al.*, 2005), manages the mobility of the subnet that may consist of Local Fixed Nodes (LFNs), Local Mobile Nodes (LMNs) and Visiting Mobile Nodes (VMNs). Each MR (as well as VMNs) have a Home Agent (HA) in the Internet. Communications within the vehicle can be with any wired/wireless technology. Communications between vehicles is with IEEE 802.11p. Selected vehicles also have a second wireless interface (e.g., 3G) for communications to roadside gateways. For position, all vehicles and gateways have built-in GPS device.

The routing protocol used within the vehicular network is not specified, but it is assumed the routing protocol can find least-cost paths across the network, e.g., from any mobile node to any destination, including a gateway. Most VANET routing protocols, e.g., Huo *et al.* (2011), or enhanced MANET routing protocols, e.g. Sharma *et al.* (2006), Tingrui *et al.* (2011), would be suitable.

Ipv6 is used as the network layer. AUTOCONF and IPv6 stateless address autoconfiguration are used for assigning IP addresses to MR/MN. Mobile IPv6 is used for handovers between gateways. That is, to inform a MN/MRs home agent of its new address binding Mobile IPv6 Binding Update procedure is used. To reduce the delay of this procedure, support for Fast Handovers, e.g. (Koodli, 2009) or (Kusin and Zakaria, 2011), is assumed.

Gateway selection metrics: There are many metrics that can be used to determine the optimal gateway for a mobile node (performance, financial, security etc.). The final selection will depend on the network operator and user requirements.

The metrics under consideration in this study are:

Hops to gateway: The number of wireless hops the mobile node is from the gateway. This is an approximate measure

of path delay and throughput in a multi-hop wireless network. It can be easily measured and is relatively stable (compared to say the actual path delay). It is commonly used for path and gateway selection. Hops to gateway is used as a baseline metric for comparing the usefulness of other metrics and the gateway selection algorithm.

Gateway Throughput: The egress throughput remaining at the gateway. On the uplink (to the Internet) the gateway records current throughput (either at a packet/byte level or by number of sessions) and determines the remaining throughput available to new sessions.

Traffic Load: The amount of traffic in the multi-hop wireless network. Getting an accurate, up-to-date measure of load in a multi-hop wireless network can be difficult. The load is approximated by counting the number of sessions, N_{sess} , assuming each session has a sending rate of u . The sessions initiated by nodes in the vehicle, v_i , contribute to the load. Also, each vehicle, v_i , has a set of one-hop neighbours, $v_{i,neigh}$. The number of sessions that those neighbors have ongoing contributes to the load at v_i . Finally, the sessions from other nodes directed to vehicle v_i contribute to the load at v_i . Therefore the traffic load at v_i , denoted as L_i , is the sum of these three contributors:

$$L_i = (N_{i, sess} \cdot u_i) + \sum_{j \in V_{i, neigh}} N_{j, sess} \cdot u_j + \sum_{k \in V_{i, direct}} N_{k, sess} \cdot u_k \quad (1)$$

Therefore the traffic load from MN to gateway g is:

$$L_g = \sum_{i \in V_{g, route}} L_i \quad (2)$$

where $V_{g, route}$ is the set of intermediate vehicle between MN and gateway g .

Route Expiration Time (RET): A measure of how much time a MN can use a path to a gateway, i.e., the reliability of the path. Proposed by Su *et al.* (2000) each gateway embeds position, velocity and estimated RET (initially 0) in RAs. As MRs receive the RA they calculate a Link Expiration Time, update the RET and forward the RA. The RA received by vehicle v_i should have an estimate of the reliability of the path to the original gateway. LET is calculated as:

$$LET_j = \frac{-(ab + cd) + \sqrt{(a^2 + c^2)r^2 - (ad - bc)^2}}{a^2 + c^2} \quad (3)$$

where:

$$a_j = v_i \cos(\theta_i) - v_j \cos(\theta_j)$$

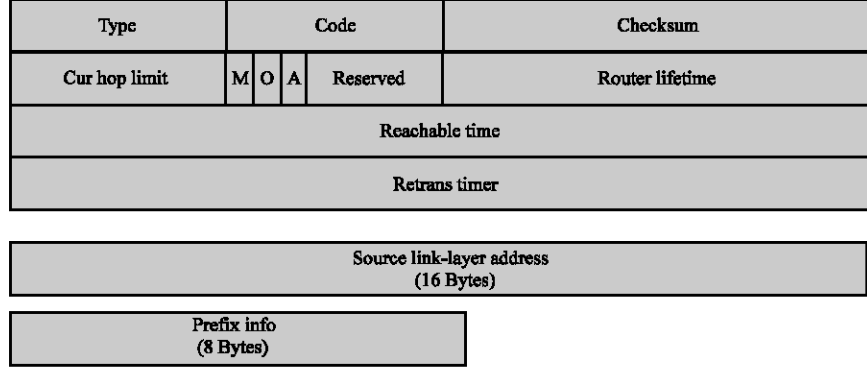

Fig. 2: Header structure for Route Advertisement packet, including optional source link-layer address and prefix info headers

$$b_{ij} = x_i - x_j$$

$$c_{ij} = v_j \sin(\theta_j) - v_i \sin(\theta_i)$$

$$d_{ij} = y_i - y_j$$

RET is calculated as:

$$RET_k = \min(LET_{ij}) \quad (4)$$

Path stability: A measure combining path reliability and length. RET measures path reliability, however a new metric is developed that also includes the path length in hops. That is, a stable path should have high reliability and low number of hops. Based on Benslimane *et al.* (2011a), the stability function of a path k is defined as:

$$S_k = 1 - e^{-\frac{RET_k}{H_k}} \quad (5)$$

where

$$p = \bar{a} \times \bar{c}$$

$$\bar{a} = (\bar{v}_i = \min(v_i)) \cos(\theta)$$

$$\bar{c} = (\bar{v}_i = \min(v_i)) \sin(\theta)$$

and $k = 1, 2, \dots$, is the number of routes to each gateway and p is a constant based on a and c as all vehicles move in the same direction.

Information collection: A mobile node must discover the available gateways and collect information to make an informed selection of the gateway to use. The Neighbor

Discovery Protocol (NDP) is designed for such tasks in IP networks. In NDP a gateway periodically broadcasts a Route Advertisement (RA) to its 1-hop neighbors. A MR that receives a RA will forward to nodes within its mobile network, i.e., LMNs, VMNs and LFNs. In addition to RAs, a MR may initiate discovery by broadcasting a Route Solicitation, to which a gateway may respond with a RA. The default format of a RA packet, including the two optional headers, is shown in Fig. 2.

NDP is designed for RA delivery across only 1 hop. The first proposed extension of NDP is to allow for RAs to traverse multiple hops (similar to that by Wakikawa *et al.* (2006)). A hop-limit is used to ensure the RA is not sent continuously, as illustrated in Fig. 3.

The second proposed extension is to carry metric information in the RA. Figure 4 illustrates the extended RA header that can carry information for the metrics listed in the previous section. Similar extensions can be defined for other metrics as needed.

With the extended NDP a gateway broadcasts a RA and receiving MRs forward the RA to its mobile network nodes, as well as to other MRs. With this approach nodes in the network can learn information about the gateway and network, even if further than 1 hop away.

Gateway selection algorithm: A VMN or LMN on-board a vehicle must choose the appropriate gateway to the Internet. The proposed method requires gateways to periodically broadcast metric information using the extended RA's (Fig. 4). As MN's receive RAs they use the information to calculate a gateway index for each gateway and then select the gateway with the highest index. The gateway selection algorithm is shown in Fig. 5.

A MN receives RAs, containing information about the network, at varying times. Each MN is configured with a decision interval, p , the time between updating the gateway index. When it is time to update the gateway

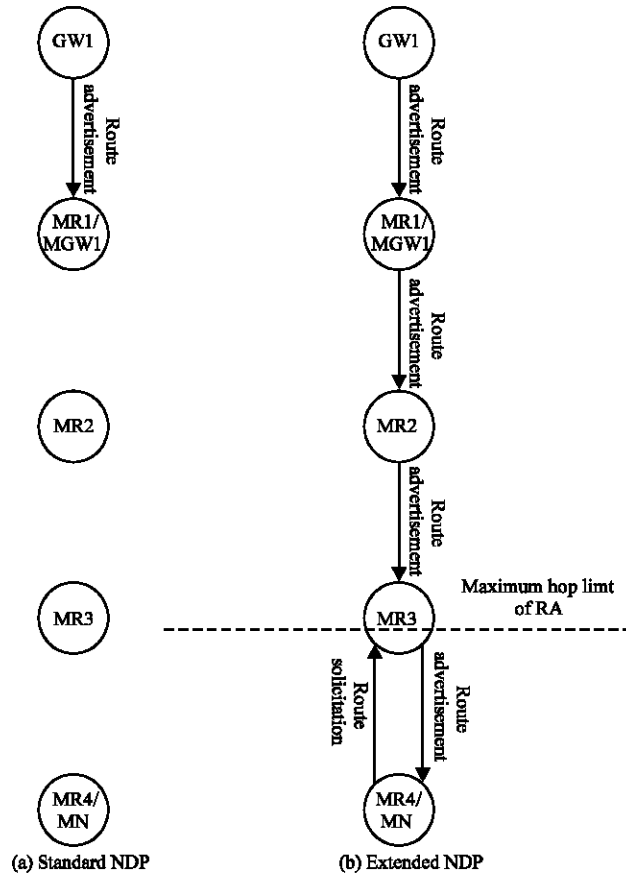

Fig. 3(a-b): Comparison of hop limits in NDP, (a) Standard NDP allows only 1-hop, (b) The proposed extension supports multiple hops. GW: Gateway, MR: Mobile Router, MGW: Mobile Gateway, MN: Mobile Node, RA: Route Advertisement

Code (000)	Length (13 bits)	Hop to GW (1 Byte)			
Code (001)	Length (13 bits)	GPS (8 Bytes)			
Code (010)	Length (13 bits)	GW throughput remaining (2 Bytes)			
Code (011)	Length (13 bits)	Traffic load of MR 1 (2 Bytes)	...	Traffic load of MR N (2 Bytes)	
Code (100)	Length (13 bits)	Financial cost of GW (2 Bytes)			
Code (101)	Length (13 bits)	Sender position (8 Bytes)	Sender speed (4 Bytes)	Sender direction (1 Byte)	Estimated RET (2 Bytes)

Fig. 4: Structure of the proposal optional headers for Route Advertisement to carry metric information

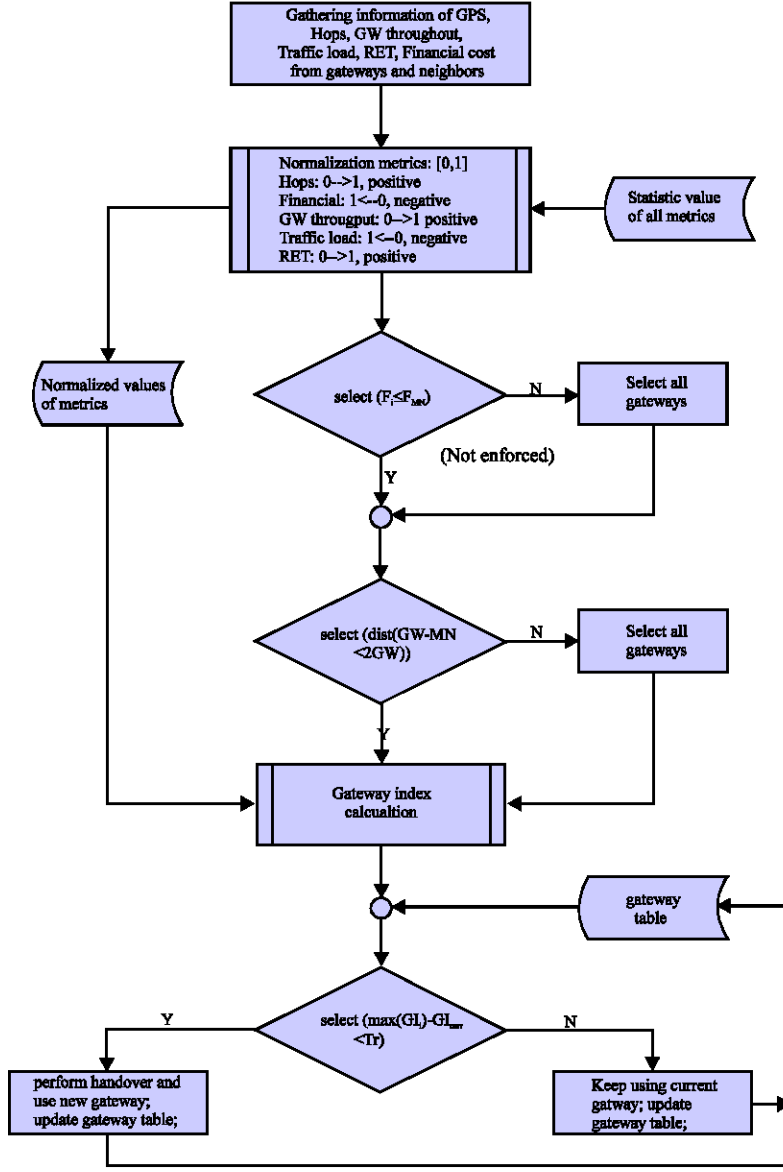

Fig. 5: Proposed gateway selection algorithm executed by MN/MR

index the MN uses information from the most recent RAs it has received from gateways. The first step is to normalize the metrics based on a Simple Additive Weighting. Positive metrics (those for which higher is better, i.e., gateway throughput and path stability) are normalized as:

$$\text{normP}(M_i) = \frac{M_i - M^{\max}}{M^{\max} - M^{\min}} \quad (6)$$

where M_i is the most recent value from gateway i , M^{\max} is the maximum value of that metric across all gateways and M^{\min} is the minimum. Similarly, negative metrics (e.g., hops, traffic load) are normalized as:

$$\text{normN}(M_i) = \frac{M^{\max} - M_i}{M^{\max} - M^{\min}} \quad (7)$$

In general, the gateway index is a weighted sum of the individual normalized metrics, i.e.:

$$DI_i = \sum_{m \in [TH, RET, S_i]} w_m \cdot \text{normP}(m) + \sum_{m \in [H, R, L_i]} w_m \cdot \text{normN}(m) \quad (8)$$

The effectiveness of the gateway index in identifying the best gateway depends on the weights chosen. To evaluate the architecture different combinations of metrics are considered. Hops to gateway (H) is used as a baseline in this study. The hop count is commonly used in routing

Table 1: Prioritized weights for gateway selection metrics that depend upon application and user requirements

Set	App	Priority	Highest	High	Medium	Low	Unused
1	VoIP	Delay	W_H	W_{RET}	W_L	W_{TH}	W_F
2	VoIP	Cost	W_F		W_{RET}, W_H	W_{TH}, W_L	
3	VoIP	Both		W_H, W_F	W_{RET}	W_{TH}, W_L	
4	Video	Throughput	W_{TH}	W_L	W_{RET}	W_H	W_F
5	Video	Cost	W_F		W_{TH}, W_L	W_{RET}, W_H	
6	Video	Both		W_{TH}, W_F	W_L	W_{RET}, W_H	

protocols for choosing the best path and is relatively easy to find up-to-date values. The hops to gateway metric is referred to this as the standard metric (STD): $w_H = 1$ and all other weights are 0. The impact of using the other performance metrics on their own, i.e., gateway throughput (TH), traffic load (L), RET and stability (S) (referred to as P1 to P4, respectively) is also considered in the analysis.

To evaluate selecting gateways using a combination of metrics requires weighting the metrics depending on the requirements of the user and network operator. Although there are many variations of such requirements that cannot be predicted, a set of weight values based on typical application requirements is suggested. Considering the metrics previously discussed. Six different sets of weights are suggested to support requirements of VoIP and video streaming (or throughput intensive file transfer) applications. For VoIP, delay is of primary importance (Set 1). However financial cost may also be a high user requirement (Set 2), or some combination (Set 3). For video streaming, throughput is a main performance metric (Set 4). But again a user may wish to minimize financial cost (Set 5) or both (Set 6).

For each set of weights, the weight of the primary metric to set to be the highest value (or in the case of cost and a performance metric being important, set the two weights to be equal highest). Then the remaining metrics are given lower weights ranked by importance. For VoIP the order of importance is number of hops (which impacts on delay), RET, traffic load and throughput. For streaming video the order of importance is throughput, traffic load, RET and number of hops. Table 1 summarizes the weights for the six sets:

At each decision time point a MN uses the collected information from gateways to select a gateway. First the metric values are normalized. Before using the values an initial check on the financial cost is performed. If a user has specified a maximum financial cost, then any gateways that exceed this amount will be disregarded. Next, of the remaining candidate gateways distance criteria must be met: candidate gateways outside this predefined distance will be disregarded. Next the gateway index is calculated for all remaining candidate gateways. Finally, will handover to a gateway that has an index higher than the current gateway. To avoid excessive handovers, the new gateway index must exceed the current gateways index by some threshold, Tr .

Table 2: Default and range of parameter values used in simulations

Parameter	Values
Number of gateways	5
Gateway separation	1000 m
Gateway uplink capacity	4 to 14 Mb sec ⁻¹
Gateway RA interval	100 ms
Gateway charge rate	0.2 to 1.2 Baht/MB
Highway lanes	2
Highway length	4000 m
Vehicle density	0.01 to 0.05 vehicle m ⁻¹
Vehicle speed	80 to 120 km h ⁻¹
Session data rate	64 to 512 kb sec ⁻¹
Sessions per vehicle	0 to 2 sessions
Number of 3G capable vehicles	20% of all vehicles
Handover threshold, Tr	20%

Performance evaluation: To demonstrate the effectiveness of the proposed gateway selection algorithm and to illustrate the tradeoffs in the different metrics, a highway network is simulated in MATLAB with the following performance metrics collected:

- Application throughput as determined by the load on the gateways
- Signalling overhead incurred by information collection (i.e., RAs), exchange of information between gateways and handovers (e.g., Mobile IPv6 Binding Updates). In determining the total signaling overhead packets sent across the Internet (W_{int}), sent across the vehicular network (W_{h1}) and sent within the vehicle (W_{h2}) are weighted differently. Namely, $W_{int} = 1$, $W_{h1} = 2$ and $W_{h2} = 0.1$

The objective is to show how the gateway selection algorithm performs when using different metrics. The metrics used in this paper are: hops only (STD); Gateway throughput only (P1); Traffic load only (P2); RET only (P3); Path stability only (P4); A combination of hops, financial cost, gateway throughput, load and RET, weighted according to a set chosen from Table 1 (P5); And a combination of stability, financial cost, gateway throughput and load, weighted according to a set chosen from Table 1 (P6). These metrics are considered in different scenarios. In particular the impact of number of gateways and the uplink capacity of those gateways is analyzed. Also the density of vehicles on the highway and the charge rate is varied. Key parameter values are listed in Table 2.

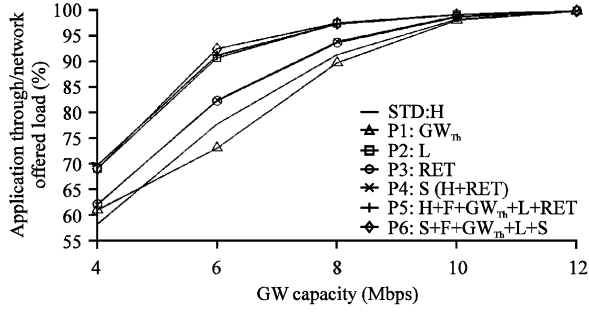

Fig. 6: Average application throughput/network offered load versus gateway throughput capacity, with weighting function Set 4, fixed gateway charge rate

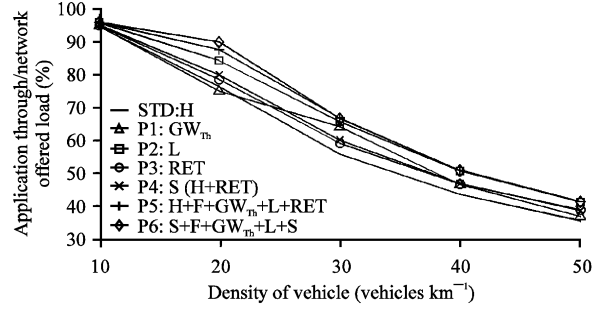

Fig. 9: Average application throughput/network offered load versus vehicle density, with weighting function Set 4, fixed gateway charge rate, capacities Low-High-Low-High-Low

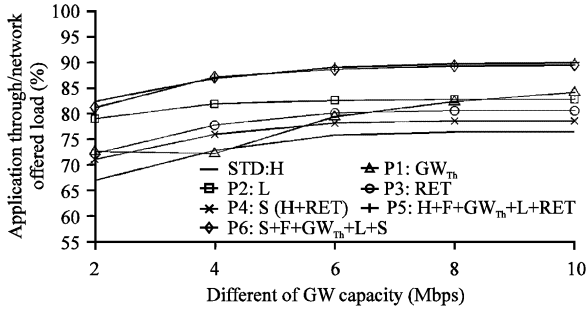

Fig. 7: Average application throughput/network offered load versus difference in gateway throughput capacity, with weighting function Set 4, fixed gateway charge rate, capacities High-Low-High-Low-High

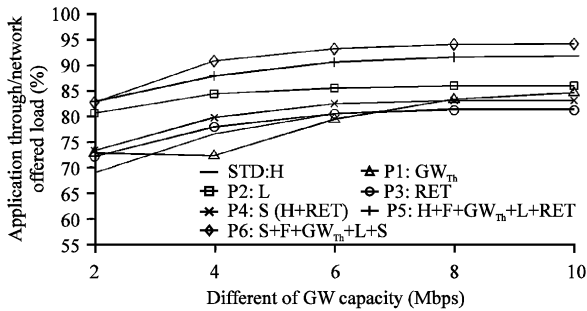

Fig. 8: Average application throughput/network offered load versus difference in gateway throughput capacity, with weighting function Set 4, fixed gateway charge rate, capacities Low-High-Low-High-Low

Figure 6 shows the application throughput (averaged across all nodes/sessions) as a percentage of the network

offered load. The throughput depends upon the uplink capacity of the gateways. When all gateways have an uplink capacity of 12Mb/s, it is sufficient to support all application sessions all the time. For smaller gateway capacities, some sessions will not be fully supported, i.e., a gateway may be overloaded. Figure 6 shows how using different metrics impacts on application throughput when the gateway capacity is insufficient for all sessions. Using multiple metrics (P5 and P6) offers a 5-10% increase over using only one metric. There is a smaller increase in using RET or load as the metric compared to the standard metric of hop count, but this increase on its own may not outweigh the extra complexity of using RET or load (signaling overhead will be shown shortly).

Figure 7 and 8 are similar to Fig. 6, except the gateways have varying capacities. In Fig. 7 the five gateways have capacity of High-Low-High-Low-High (i.e., first gateway has higher capacity than second gateway). The different between the High and Low capacities is plotted on the x-axis. In Fig. 8 the capacity pattern is Low-High-Low-High-Low. These arrangements are chosen to demonstrate that the gateway selection algorithm is feasible when there are varying gateway capabilities. Both sets of results show again that using multiple metrics offers increase performance against using a single metric. Also, from Fig. 6, 7 and 8 it is evident that using only gateway throughput (P2) is not an appropriate metric (it often performs worse than using the simpler hop count).

Figure 9 shows that an increased vehicle density (i.e. more vehicles in the fixed area) leads to lower application throughput. Once again combining multiple metrics (P5 and P6) delivers 5 to 10% more throughput than the individual metrics.

The financial cost is an important non-performance-related metric. Figure 10 demonstrates how the proposed

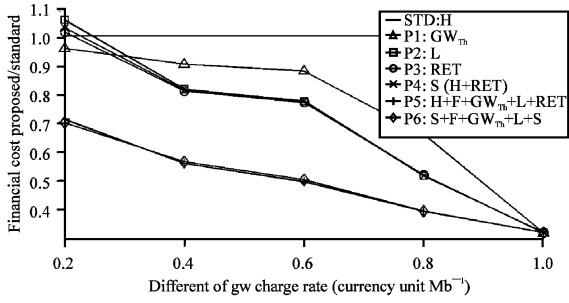

Fig. 10: Financial cost proposed/standard algorithm versus difference in gateway charge rate, with weighting function Set 5, gateway capacity 8Mb/s, gateway charge rates Low-High-Low-High-Low

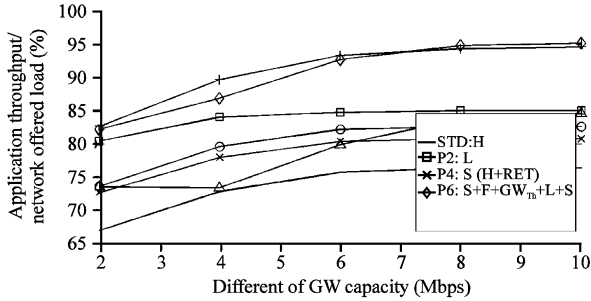

Fig. 11: Average application throughput/network offered load versus difference in gateway throughput capacity, with weighting function Set 6, fixed gateway charge rate, capacities High-Low-High-Low-High

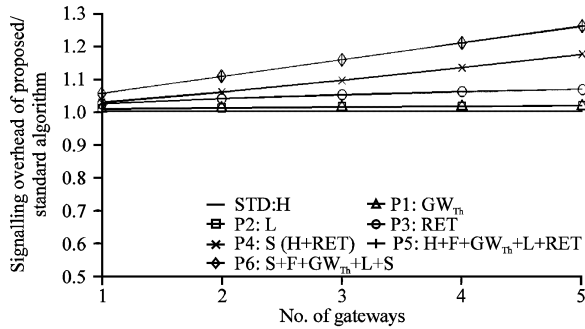

Fig. 12: Ratio of signaling overhead of proposed algorithms compared to standard versus number of gateways

algorithm can incorporate the financial cost. For metrics P5 and P6 the financial cost is now considered as a primary factor that is Set 5 is used for the weights. All

gateways have the same capacity (8 Mb sec⁻¹), but different charge rates (High-Low-High-Low-High). Figure 10 shows the total financial cost incurred relative to the standard algorithm (hops only) for varying differences between gateway charge rates. The lower the financial cost the better. As can be seen using the financial information in the gateway selection (P5 and P6) can lead to decrease in total cost of around 20% compared to P2 to P4.

The preceding results demonstrate that the proposed gateway selection algorithm can improve application throughput and/or financial cost by using multiple metrics (Fig. 11). The disadvantage of the proposed approach is the increase signaling overhead. This overhead mainly comes from broadcast multi-hop RAs that are used for MR/MN to discover capabilities of gateways. Figure 12 shows the signaling overhead when the number of gateways is increased. The overhead is relative to that incurred with the standard hops to gateway selection algorithm. That is, STD incurs overhead of 1. Using metrics P1 to P6 increases the overhead by the factor shown. With five gateways, the worst case is a 30% increase in overhead. Note however that as this is a worst case performance, in general it will be less. The overhead should be tolerable for the application performance increase offered by the proposed gateway selection algorithm.

CONCLUSIONS

This study proposed an architecture for selecting the optimal gateway for a node within a vehicle in a VANET connected to the Internet. Assuming the vehicles create a multi-hop wireless network amongst themselves and a subset of vehicles offer shared 3G/4G access to roadside base stations (gateways), mobile routers onboard the vehicles should select the best gateway for Internet connectivity. Extensions to NDP are proposed to allow Route Advertisements to: (a) Traverse multiple hops and (b) Carry information about the gateway and path to gateway. A new gateway selection algorithm for the MR is designed; the algorithm considers multiple metrics. Functions for combining the metrics are recommended, including weights based on application (VoIP, streaming video) requirements. Simulation results show the gateway selection algorithm can improve application throughput when using multiple metrics, compared to the standard hop count metric. Extra signaling overhead incurred by the proposed protocol is tolerable. Future work includes extending the architecture to support load balancing between gateways, as well as analyzing the architecture in different scenarios (e.g., grid road networks).

ACKNOWLEDGMENTS

This research was supported by the Telecommunications Research and Industrial Development Institute (TRIDI), National Telecommunications Commission (NTC), Thailand, as well as Prince of Songkhla University and partially supported by the National Research University Project of Thailand, Office of Higher Education Commission.

REFERENCES

- Alrashdan, M., M. Ismail, K. Jumari, G.A. Abed and S. Hassan, 2011. Performance comparison analysis of SSHMIPv6 and HMIPv6 lost packets using network simulator NS-2. *Infor. Technol. J.*, 10: 1989-1993.
- Benslimane, A., S. Barghi and C. Assi, 2011. An efficient routing protocol for connecting vehicular networks to the internet. *Pervasive Mobile Comp.*, 7: 98-113.
- Benslimane, A., T. Taleb and R. Sivaraj, 2011. Dynamic clustering-based adaptive mobile gateway management in integrated VANET-3G heterogeneous wireless networks. *IEEE J. Selected Areas Commun.*, 29: 559-570.
- Bin, Y. and S. Bin, 2009. Modify AODV for MANET/Internet connection through multiple mobile gateways. *Proceedings of the International Conference on Advanced Communication Technology*, October 12-14, 2009, Phoenix Park, Korea, pp: 1519-1523.
- Bouk, S.H. and I. Sasase, 2009. Multiple end-to-end QoS metrics gateway selection scheme in mobile ad hoc networks. *Proceedings of the 58th IEEE International Conference on Emerging Technologies*, December 22-36, 2009, Islamabad Pakistan, pp: 446-451.
- Devarapalli, V., R. Wakikawa, A. Petrescu and P. Thubert, 2005. Network mobility (NEMO) basic support protocol. RFC 3963, January 2005.
- Dhar, S., A. Ray, S. Chakravorty and R.N. Bera, 2011. Intelligent vertical handover scheme for utopian transport scenario. *Trends Applied Sci. Res.*, 6: 958-976.
- Dinakaran, M. and P. Balasubramanie, 2012. Improving the performance of packet transfer in network mobility. *Infor. Technol. J.*, 11: 596-604.
- Ding, S., 2008. A survey on integrating MANETs with the Internet: Challenges and designs. *Comp. Commun.*, 31: 3537-3551.
- Hoffmann, F. and D. Medina, 2009. Optimum internet gateway selection in ad hoc networks. *Proceedings of the International Conference on Communications*, June 18, 2009, Dresden Germany, pp: 1-5.
- Huo, M., Z. Zheng, X. Zhou and J. Ying, 2011. PCAR: A packet-delivery conditions aware routing algorithm for vanet networks. *Infor. Technol. J.*, 10: 1334-1342.
- Koodli, R., 2009. Mobile Ipv6 fast handovers. IETF RFC 5568. <http://www.citeulike.org/user/shstrom/article/9499610>.
- Kusin, Z. and M.S. Zakaria, 2011. Distance based mobility anchor point selection scheme with dynamic load control in hierarchical mobile IPV6. *Infor. Technol. J.*, 10: 1817-1823.
- Le-Trung, Q., P.E. Engelstad, T. Skeie and A. Taherkordi, 2008. Load-balance of intra/inter-MANET traffic over multiple internet gateways. *Proceedings of the 6th International Conference on Advances in Mobile Computing and Multimedia*, November 24-26, 2008, Linz, Austria, pp: 50-57.
- Ma, W. and J. Liu, 2009. A gateway selection scheme for internetworking of MANET and internet using improved genetic algorithm. *Proceedings of the 5th International Conference on Wireless Communications, Networking and Mobile Computing*, September 24-26, 2009, Beijing, China, pp: 1-4.
- Park, B.N., W. Lee and C. Lee, 2007. Qos-aware internet access schemes for wireless mobile ad hoc networks. *J. Comp. Commun.*, 30: 369-384.
- Setiawan, F.P., S. Bouk and I. Sasase, 2009. Multiple metrics gateway selection scheme in mobile ad hoc network (MANET) and infrastructure network integration. *IEICE Trans. Commun.*, 92: 2619-2627.
- Sharma, S., R.C. Jain and S.S. Bhadauria, 2006. Simulation study of congestion adaptive routing algorithm for mobile Ad hoc network. *Trends Applied Sci. Res.*, 1: 368-378.
- Sheng, S.P., B.Y. Chang and H.Y. Wei, 2008. Access gateway discovery and selection in hybrid multihop relay vehicular network. *Proceedings of the 3rd IEEE Asia-Pacific Services Computing Conference*, December 9-12, 2008, Yilan, Taiwan, Pp: 1595-1599.
- Su, W., S.J. Lee and M. Gerla, 2000. Mobility prediction in wireless networks. *Proc. IEEE Military Commun. Conf.*, 1: 440-445.
- Sun, B., W. Zhang and B. Yu, 2009. Modify OLSR for MANET/Internet interconnecting with mobile gateways. *Proceedings of 1st IEEE International Conference on Network Infrastructure and Digital Content*, November 6-8, 2009, Beijing, China, pp: 110-113.
- Tingrui, P., Z. Zhi, Z. Wenli and Z. Zhaoxia, 2011. A cognitive improved hierarchical AODV routing protocol for cognitive wireless mesh network. *Infor. Technol. J.*, 10: 376-384.
- Wakikawa, R., J. Malinen, C. Perkins, A. Nilsson and A. Tuominen, 2006. Global connectivity for IPv6 Mobile Ad Hoc Networks. IETF Internet Draft work in progress.