

# Data Communications and Networks

## ITS323: Introduction to Data Communications

Sirindhorn International Institute of Technology  
Thammasat University

Prepared by Steven Gordon on 23 May 2012

ITS323Y12S1L01, Steve/Courses/2012/s1/its323/lectures/datacomms.tex, r2334

# Contents

## Motivation

## A Communications Model

## Data Communications

## Networks

## The Internet

## Examples

# What Is Data Communications?

- ▶ When we communicate we are sharing information
  - ▶ Local sharing, e.g. face-to-face
  - ▶ Remote sharing, e.g. over some distance
- ▶ Data: information being shared, e.g. text, numbers, images, audio, video
- ▶ Data Communications: exchange of data between two (or more) devices via some transmission medium

# Effective Data Communications

**Delivery:** the data must be delivered to the correct destination

**Accuracy:** the data received must be accurate representation of the data sent

**Timeliness:** the data should be delivered within a reasonable time

# Contents

Motivation

**Model**

Data Comms

Networks

The Internet

Examples

Motivation

**A Communications Model**

Data Communications

Networks

The Internet

Examples

# Simplified Communications Model

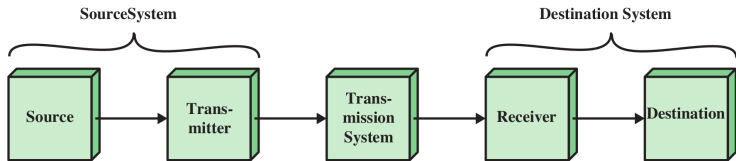

**Source:** Device that generates data to be transmitted

**Transmitter:** Converts data from source into transmittable signals

**Transmission system:** Carries data from source to destination

**Receiver:** Converts received signal into data

**Destination:** Takes and uses incoming data

# Simplified Communications Model

## An Example

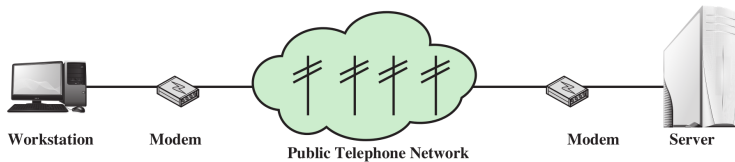

# Communications Tasks

Simplified communications model makes it look easy ... but there are many tasks to be performed in a data communications system

Transmission system utilization	Addressing
Interfacing	Routing
Signal generation	Recovery
Synchronization	Message formatting
Exchange management	Security
Error detection and correction	Network management
Flow control	



# Categorizing Communication Technologies

**Data Communications:** transmitting signals in reliable and efficient manner; focusses on individual links

**Networks:** communications across set of links; Wide Area Networks, Local Area Networks, The Internet

# Contents

Motivation

A Communications Model

**Data Communications**

Networks

The Internet

Examples

# A Data Communications Model

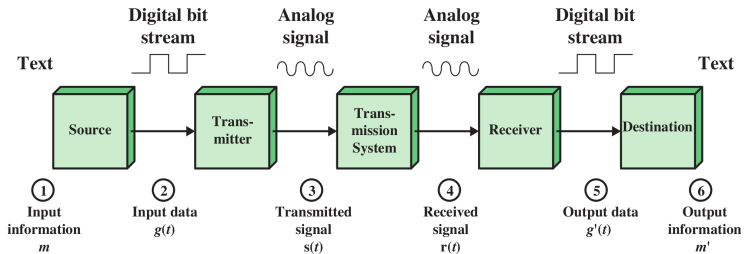

# Transmission Line

- ▶ Transmission line (or system) is key part of communications system
- ▶ “Link” between transmitter and receiver
- ▶ Needs to provide required capacity, with acceptable reliability at minimum cost

# The Transmission of Information

## Transmission and Transmission Media

- ▶ How to convert information into transmittable electromagnetic signal?
- ▶ What transmission media to use?

## Communication Techniques

- ▶ How to encode information into a signal?
- ▶ How to deal with errors?

## Transmission Efficiency

- ▶ How to efficiently utilize/share communications system?

# Contents

Motivation

Motivation

Model

A Communications Model

Data Comms

Data Communications

**Networks**

Networks

The Internet

The Internet

Examples

Examples

# Networks

- ▶ Demand for any user to communicate with any other machine/user
- ▶ Require:
  - ▶ Communication software (see The Internet)
  - ▶ Communication network technologies: WANs and LANs

# Wide Area Networks

- ▶ Span a large geographical area
- ▶ Require crossing of public right-of-ways
- ▶ Rely on links of common carriers (telecommunication companies)
- ▶ Carries data of multiple organisations
- ▶ How to find path across a network?
- ▶ How to deliver data across the network?
- ▶ Example technologies: ATM, Frame Relay, SDH



# Local Area Networks

- ▶ Small coverage area, e.g. building, campus
- ▶ Owned and operated by organisation owning end-devices
- ▶ Higher internal (per user) data rates compared to WANs
- ▶ How to arrange nodes in a LAN?
- ▶ How to share LAN amongst multiple users?
- ▶ Example technologies: Ethernet, Wireless LAN

# Contents

Motivation

Model

Data Comms

Networks

**The Internet**

Examples

Motivation

A Communications Model

Data Communications

Networks

**The Internet**

Examples

# The Internet

## Origins

- ▶ Evolved from US Department of Defence research network, ARPANET (developed in 1969)
- ▶ Used packet switching technology (whereas telephone networks used circuit switching)
- ▶ Development and standardization of the Internet suite of protocols: TCP/IP

## What is The Internet?

- ▶ Collection of networks connected together using common software: Internet Protocol (IP)
- ▶ Although network technologies differ, any computer can communicate with any other computer (providing they are using IP)

# Key Elements of the Internet

## Hosts, routers and (sub-)networks

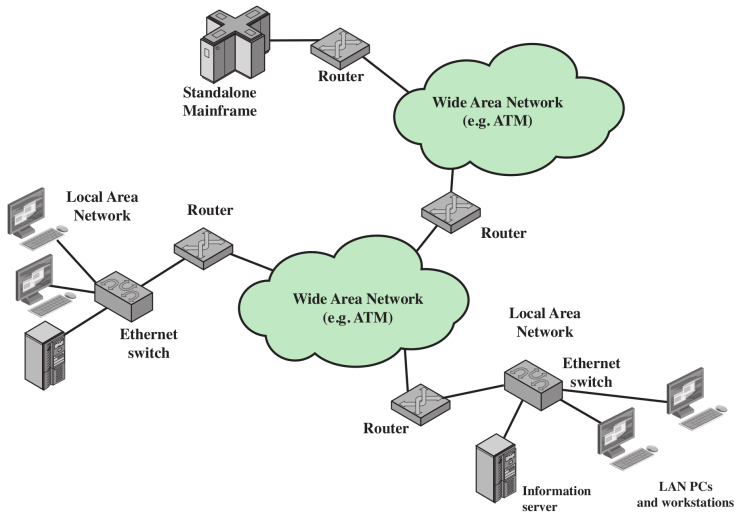

## Simplified View of Portion of Internet

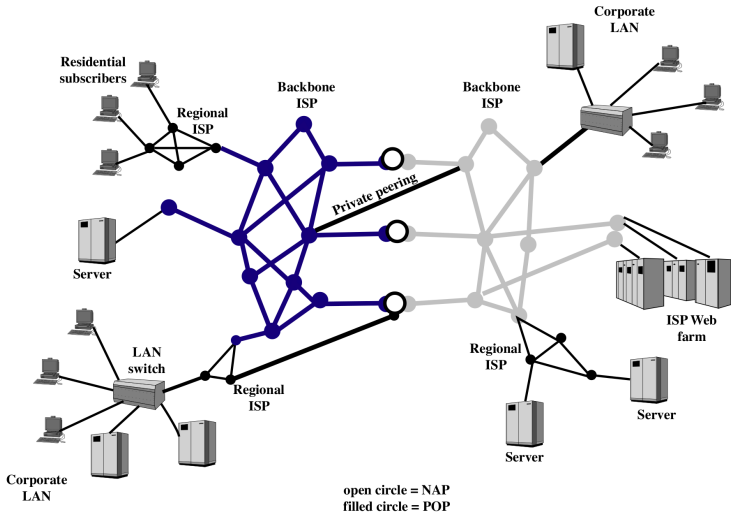

# Contents

Motivation

Motivation

Model

A Communications Model

Data Comms

Networks

Data Communications

The Internet

Networks

Examples

The Internet

Examples

# Example: SIIT

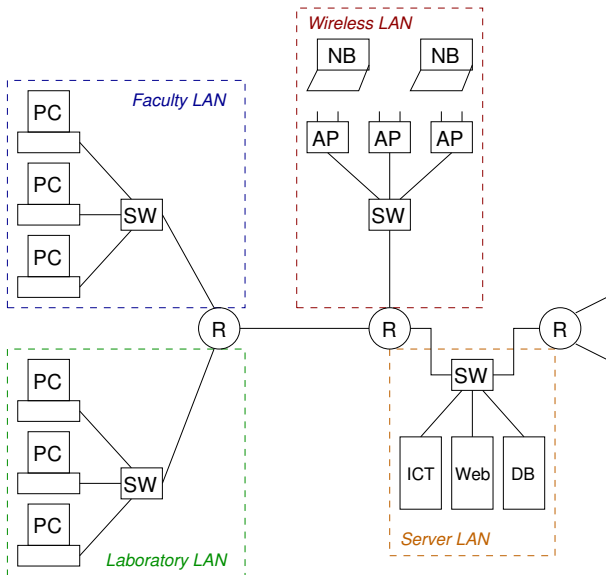

## Example: SIIT

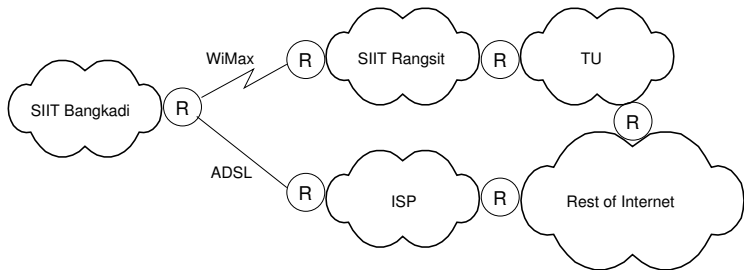

Motivation

Model

Data Comms

Networks

The Internet

Examples



# Example: Thailand Internet

See <http://internet.nectec.or.th/>

Motivation

Model

Data Comms

Networks

The Internet

Examples